

# **Procedures to File a Request to the MyIPO (Intellectual Property Corporation of Malaysia) for Patent Prosecution Highway Pilot Program between the CNIPA (China National Intellectual Property Administration)**

The pilot period of this Patent Prosecution Highway (PPH) pilot program which was commenced on July 1, 2018 for a duration of two years is now extended for further two years effective from 1 July 2020 to 30 June 2022. The pilot period may be extended if necessary until the MyIPO and CNIPA receive sufficient number of PPH requests to adequately assess the feasibility of PPH program.

The Offices may also terminate the PPH pilot program if the volume of participation exceeds manageable level, or for any other reason. Ex Ante notice will be published if the PPH pilot program is terminated.

## **PPH using the national work products from the CNIPA**

Applicants can request accelerated examination by a prescribed procedure including submission of relevant documents on an application which is filed with the MyIPO and satisfies the following requirements under the MyIPO - CNIPA PPH pilot program based on the CNIPA application.

When filing a request for the PPH pilot program, an applicant must submit a request form "Request for Participation in the Patent Prosecution Highway (PPH) Pilot Program" to the MyIPO.

### **1. Requirements**

- (a) The MyIPO application (including PCT national phase application) is**
- (i) an application which validly claims priority under the Paris Convention to the CNIPA application(s) (examples are provided in ANNEX I, Figures A, B, C, F, G and H), or**
  - (ii) a PCT national phase application without priority claim (example is provided in ANNEX I, Figure I), or**
  - (iii) an application which validly claims priority under the Paris Convention to the PCT application(s) without priority claim (examples are provided in ANNEX I, Figure J, K and L).**

The MyIPO application, which validly claims priority to multiple CNIPA or direct PCT applications, or which is the divisional application validly based on the originally filed application that is included in (i) to (iii) above, is also eligible.

**(b) At least one corresponding application exists in the CNIPA which has one or more claims that are determined to be patentable/allowable by the CNIPA.**

The corresponding application(s) can be the application which forms the basis of the priority claim, an application which derived from the CNIPA application which forms the basis of the priority claim (e.g., a divisional application of the CNIPA application or an application which claims domestic priority to the CNIPA application (see Figure C in Annex I)), or an CNIPA national phase application of a PCT application (see Figures H, I, J, K and L in Annex I).

Claims are “determined to be allowable/patentable” when the CNIPA examiner explicitly identified the claims to be “allowable/patentable” in the latest office action, even if the application has not been granted yet.

The office action may be either:

- i) Decision to Grant a Patent
- ii) First/Second/Third/...Office action
- iii) Decision of Refusal
- iv) Reexamination Decision, and
- v) Invalidation Decision

**(c) All claims in the MyIPO application (for which an accelerated examination under the PPH pilot program is requested), as originally filed or as amended, must sufficiently correspond to one or more of those claims indicated to be patentable/allowable in the CNIPA.**

Claims are considered to “sufficiently correspond” where, aside from differences due to translations and claim format, the claims in the MyIPO application are of the same or similar scope as the claims in the CNIPA application, or the claims in the MyIPO are narrower in scope than the claims in the CNIPA.

In this regard, a claim that is narrower in scope occurs when CNIPA claim is amended to be further limited by an additional technical feature that is supported in the specification (description and/or claims).

A claim in the MyIPO which introduces a new/different category of claims to those claims indicated to be patentable/allowable in the CNIPA is not considered to sufficiently correspond. For example, if the CNIPA claims only contain claims to a process of manufacturing a product, then the claims in the MyIPO are not considered to sufficiently correspond if the MyIPO claims introduce product claims that are dependent on the corresponding process claims.

It is not necessary to include “all” claims determined to be patentable/allowable in the CNIPA in an application in the MyIPO (the deletion of claims is allowable). For example, in the case where an application in the CNIPA contains 5 claims determined to be patentable/allowable, the application in the MyIPO may contain only 3 of these 5 claims. Any claims amended or added after the grant of the request for participation in the PPH

pilot program but before the MyIPO first office action must sufficiently correspond to the claims indicated as patentable/allowable in the CNIPA application.

- (d) *The MyIPO application must be made available for public inspection after 18 months.***
- (e) *A “Request for Substantive Examination” must have been filed at the MyIPO either at the time of the PPH request or previously.***
- (f) *The MyIPO has not begun examination of the application at the time of filing the PPH request.***

## **2. Documents to be submitted**

Documents (a) to (c) below must be submitted by attaching form “Request for Participation in the Patent Prosecution Highway (PPH) Pilot Program”. Note that even when it is not needed to submit certain documents below, the name of the documents must be listed in the form “Request for Participation in the Patent Prosecution Highway (PPH) Pilot Program” (Please refer to the example form below for the details).

- (a) *Copies of all office actions (which are relevant to substantial examination for patentability in the CNIPA which were issued for the corresponding application by the CNIPA, and translations thereof).***

Either Malay or English is acceptable as translation language. Machine translation will be admissible. If it is impossible for the examiner to understand the translated office action due to insufficient translation, the examiner can request the applicant to resubmit translations.

- (b) *Copies of all claims determined to be patentable/allowable by the CNIPA, and translations thereof.***

Either Malay or English is acceptable as translation language. If it is impossible for the examiner to understand the translated claims, the examiner can request the applicant to resubmit translations.

**(c) Copies of references cited by the CNIPA examiner**

The documents to be submitted are those cited in the above-mentioned office actions. Documents which are only referred to as references and consequently do not constitute reason for refusal do not have to be submitted.

If the references are patent documents, the applicant does not have to submit them. When the MyIPO does not possess the patent document, the applicant has to submit the patent document at the examiner's request. Non-patent literature must always be submitted. The translations of the references are unnecessary.

**(d) Claim correspondence table**

The applicant requesting PPH must submit a claim correspondence table, which indicates how all claims in the MyIPO application sufficiently correspond to the patentable/allowable claims in the CNIPA application.

When claims are just literal translation, the applicant can just write down that "they are the same" in the table. When claims are not just literal translation, it is necessary to explain the sufficient correspondence of each claim.

When the applicant has already submitted above documents (a) to (d) to the MyIPO through simultaneous or past procedures, the applicant may incorporate the documents by reference and does not have to attach them.

**3. Example of "Request for Participation in the Patent Prosecution Highway (PPH) Pilot Program" for filing request of an accelerated examination under the PPH pilot program**

**(a) Circumstances**

When an applicant files a request for an accelerated examination under the PPH pilot program to the MyIPO, the applicant must submit a request "Request for Participation in the Patent Prosecution Highway (PPH) Pilot Program".

The applicant must indicate that the application is included in (i) to (iii) of 1. (a), and that accelerated examination is requested under the PPH pilot program. The application number, publication number, or a patent number of the corresponding CNIPA application(s) must also be indicated.

Where the application with one or more claims determined to be patentable/allowable is different from the CNIPA application(s) included in (i) to (iii) of 1. (a) (for example, the divisional

application of the basic application), the application number, publication number, or a patent number of the application(s) which has claims determined to be patentable/allowable and the relationship between those applications must also be explained.

**(b) Documents to be submitted**

The applicant must list all required documents mentioned in point 2. above in an identifiable way, even when the applicant is exempted from submitting certain documents.

**4. Procedure for the accelerated examination under the PPH pilot program**

The MyIPO decides whether the application can be entitled to the status for an accelerated examination under the PPH when it receives a request with the documents stated above. When the MyIPO decides that the request is acceptable, the application is assigned to PPH Task Force for an accelerated examination under the PPH.

In those instances where the request does not meet all the requirements set forth above, the applicant will be notified and the defects in the request will be identified. The applicant may be given opportunity to correct certain specified defects.

If the request is not approved, the applicant may resubmit the request up to one time. If the resubmitted request is still not approved, the applicant will be notified and the application will await action in its regular turn (refer to ANNEX I: Figure N and O)



## Request for participation in the Patent Prosecution Highway (PPH) Pilot Programme

### A. Application Data

Application Number : \_\_\_\_\_  
 Filing Date : \_\_\_\_\_  
 Applicant : \_\_\_\_\_  
 Title of Invention : \_\_\_\_\_

### B. Request

The applicant requests participation in the Patent Prosecution Highway (PPH) pilot program based on:

Office of Earlier Examination (OEE) : \_\_\_\_\_

OEE Application Number : \_\_\_\_\_  
 (National or PCT application number)

OEE Work Products Type :

National/Regional Office Action(s)

International Authority Action(s) (ISA, IPEA or IPER)

OEE application filing/priority date : \_\_\_\_\_

**C. Required documents**

The following documents are attached:

1.  A copy of OEE work products;  
 Translation of the documents in English or Malay Language; or  
 The office is requested to retrieve these documents via the Dossier Access System or PATENTSCOPE or AIPN (list to be provided)
2.  Copies of all claims determined to be patentable/allowable by OEE;  
 Translations of the documents in English or Malay Language; or  
 The office is requested to retrieve these documents via the Dossier Access System or PATENTSCOPE or AIPN (list to be provided)
3.  A copy of non-patent documents cited in OEE work products;  
 Translations of the documents in English or Malay Language.
4.  Claim Correspondence Table.
5.  If any of the above mentioned documents have been submitted before, please specify application number and date of submission.

Application number : \_\_\_\_\_

Date of submission : \_\_\_\_\_

**D. Name and Signature of applicant or agent:**

Name and signature

Date:

\_\_\_\_\_

\_\_\_\_\_

## Claim Correspondence Table

The claim in the MyIPO application	The patentable claim in the OEE application	Remarks about the correspondence



# ANNEX I

**A**

A case meeting requirement (a) (i)  
- Paris route -

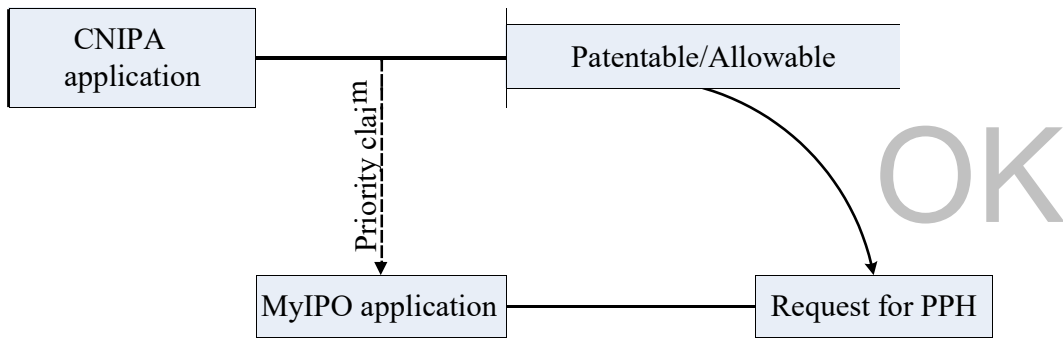

**B**

A case meeting requirement (a) (i)  
- PCT route -

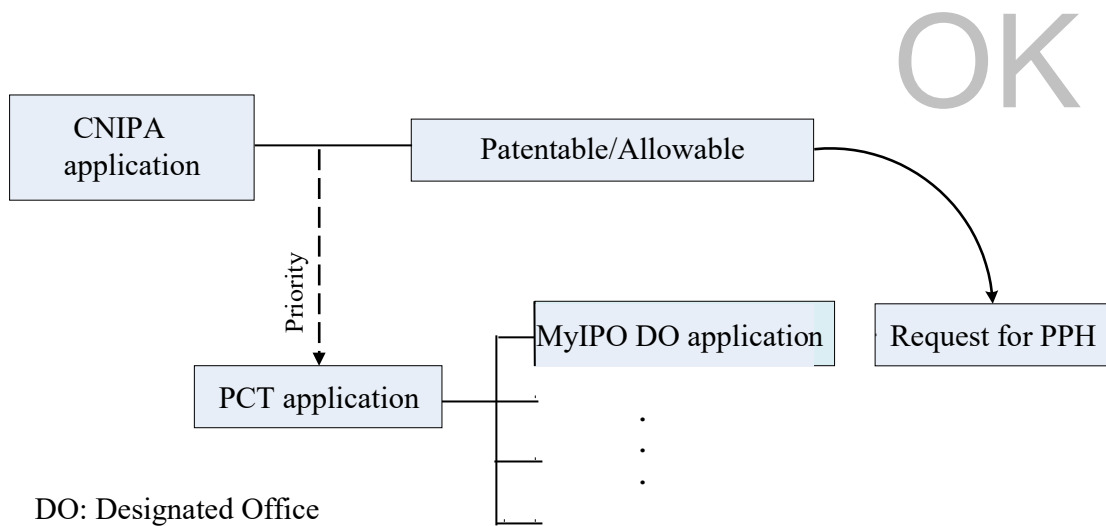

C

A case meeting requirement (a) (i)  
- Paris route, Domestic priority -

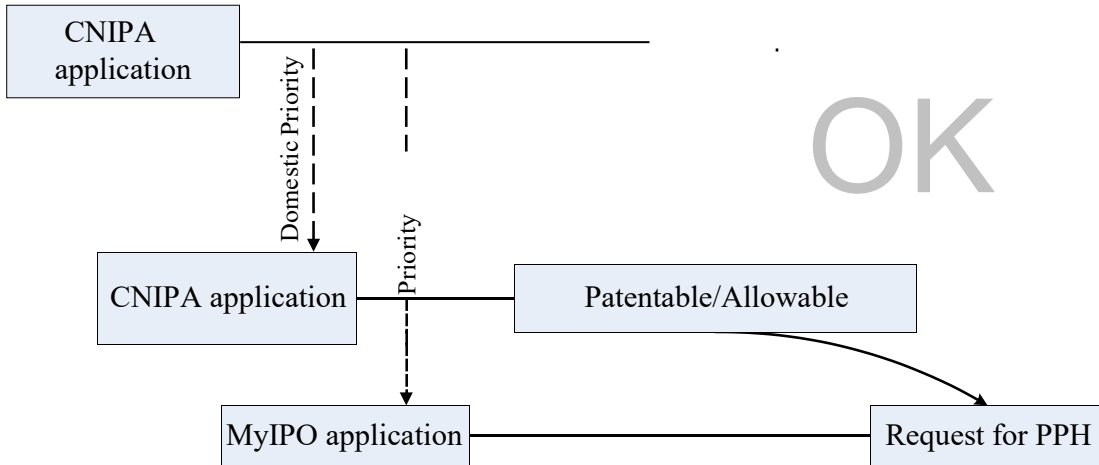

D

A case not meeting requirement (a)  
- Paris route, but the first application is from the third country -

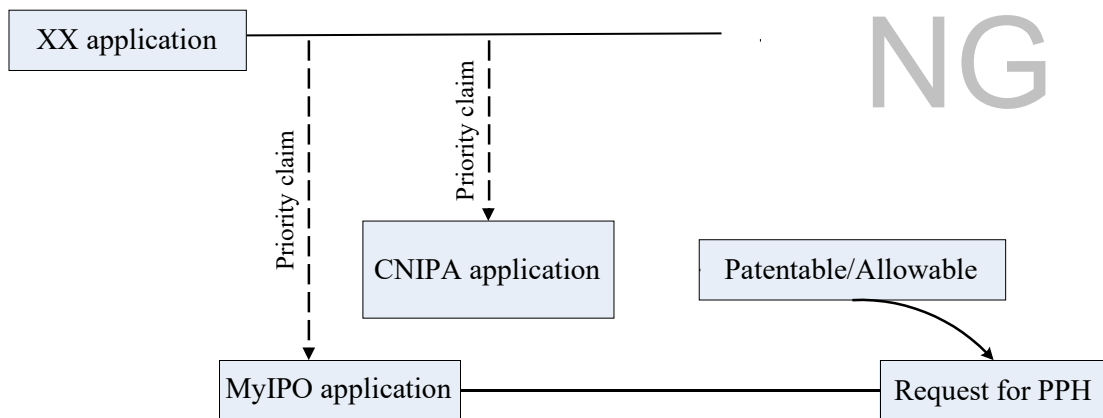

XX: the office other than the CNIPA

**E**

A case not meeting requirement (a)  
- PCT route, but the first application is from the third country -

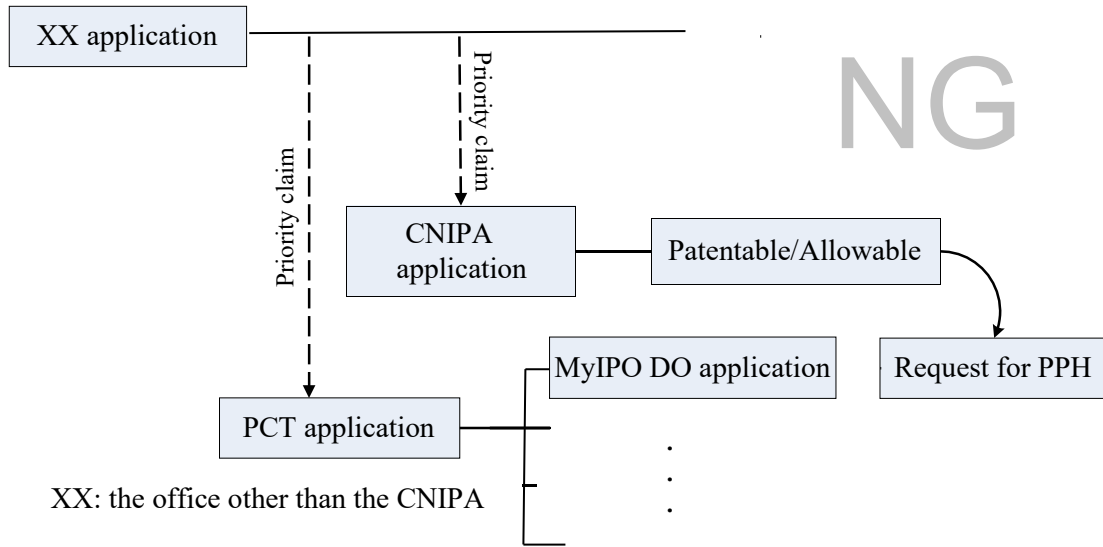

**F**

A case meeting requirement (a) (i)  
- Paris route & complex priority -

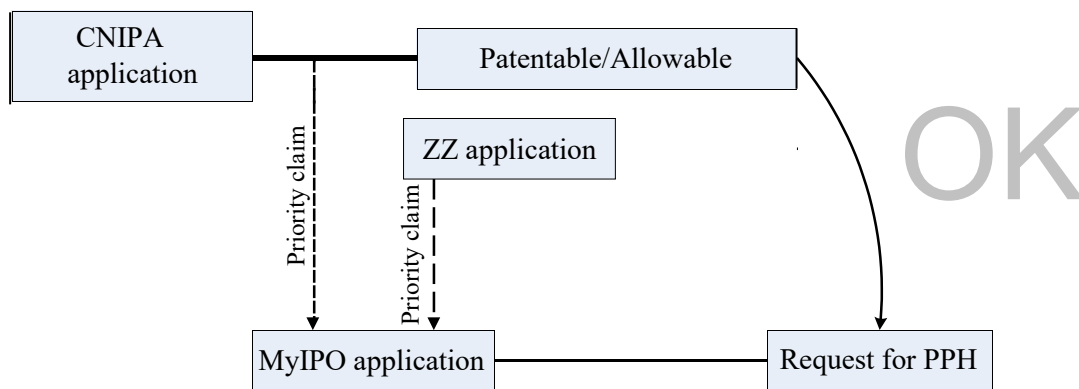

ZZ: any office

(The first application is from the CNIPA)

G

A case meeting requirement (a) (i)  
- Paris route & divisional application -

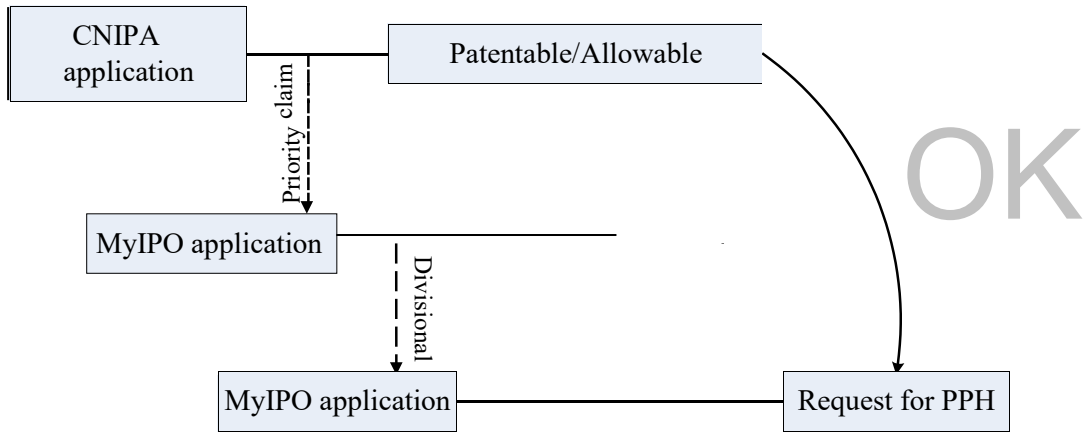

H

A case meeting requirement (a) (i)  
- PCT route -

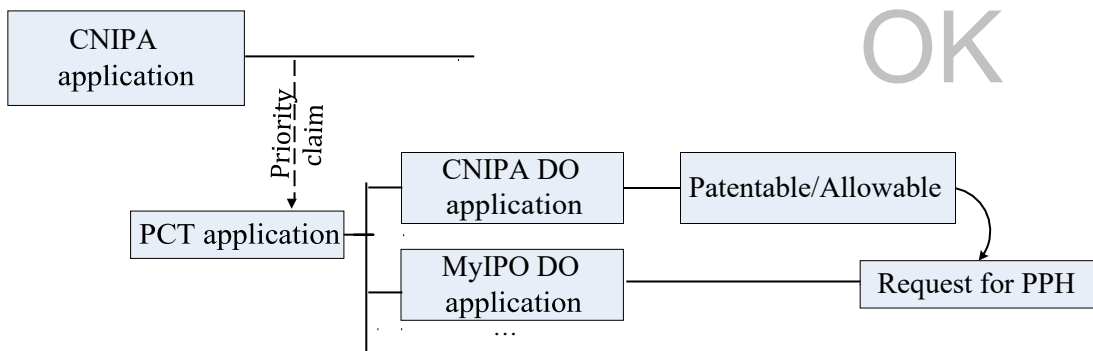

I

A case meeting requirement (a) (ii)

OK

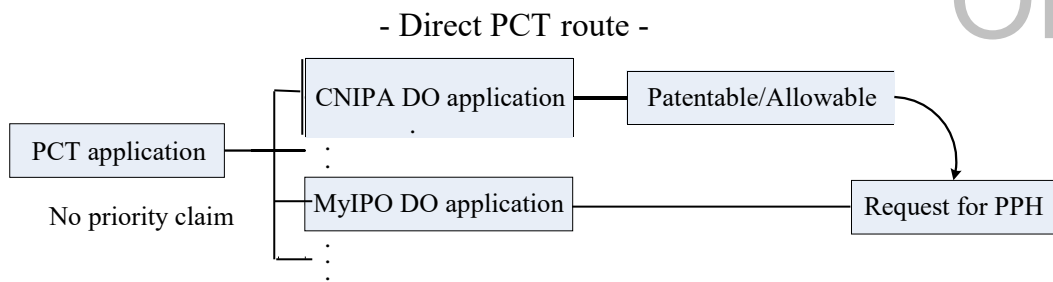

J

A case meeting requirement (a) (iii)  
- Direct PCT & Paris route -

OK

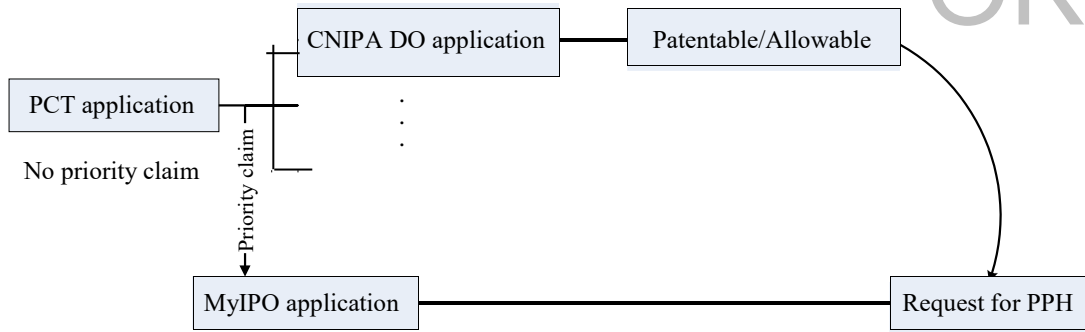

K

A case meeting requirement (a) (iii)  
- Direct PCT & PCT route -

OK

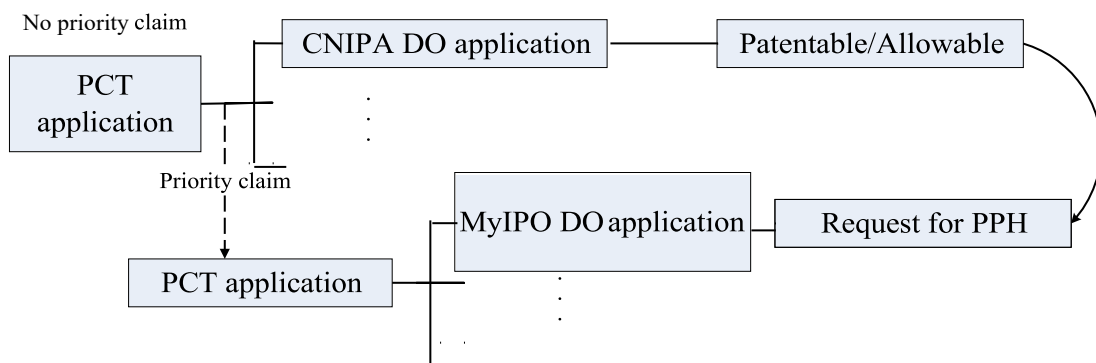

L

A case meeting requirement (a) (iii)

- Direct PCT & PCT route -

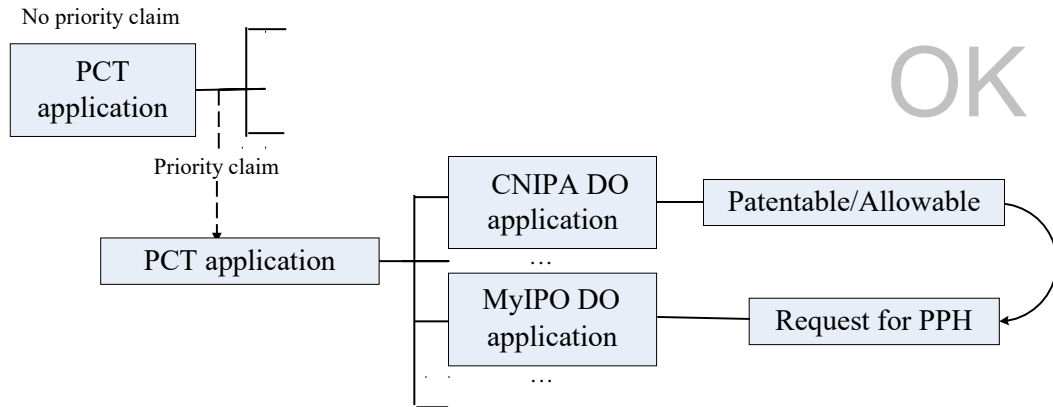

M

A case not meeting requirement (f)

- Examination has begun before a request for PPH -

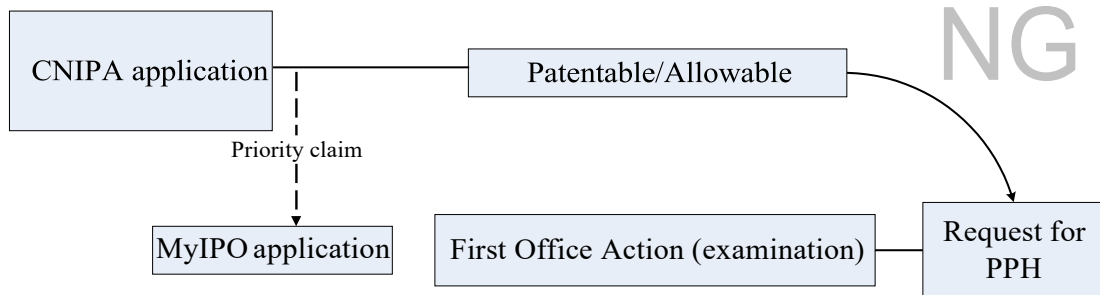

N

A case not meeting requirement (d)  
- The application has not been published at the time of request for PPH -

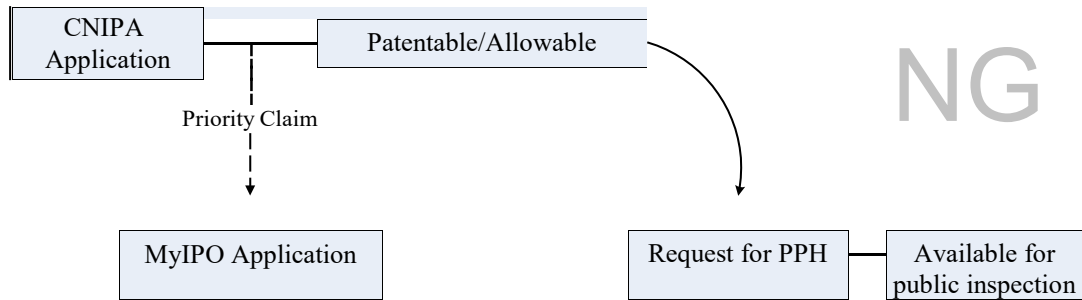

O

A case not meeting requirement (e)  
- The application has not entered into substantive examination stage at the time of request for PPH -

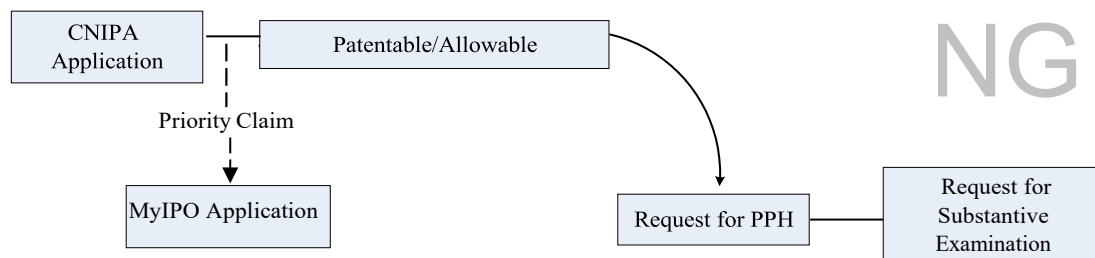





**A case meeting requirement (e) (exception)**  
- PPH request simultaneously with the Request for Substantive Examination -

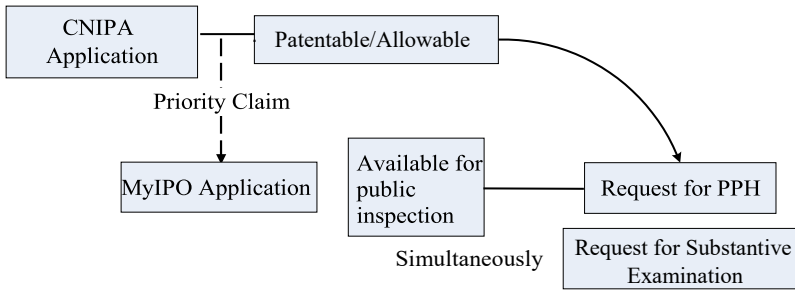

OK